

McIntosh  
MAC 4100

# OWNER'S MANUAL

## THE MCINTOSH MAC 4100 RECEIVER

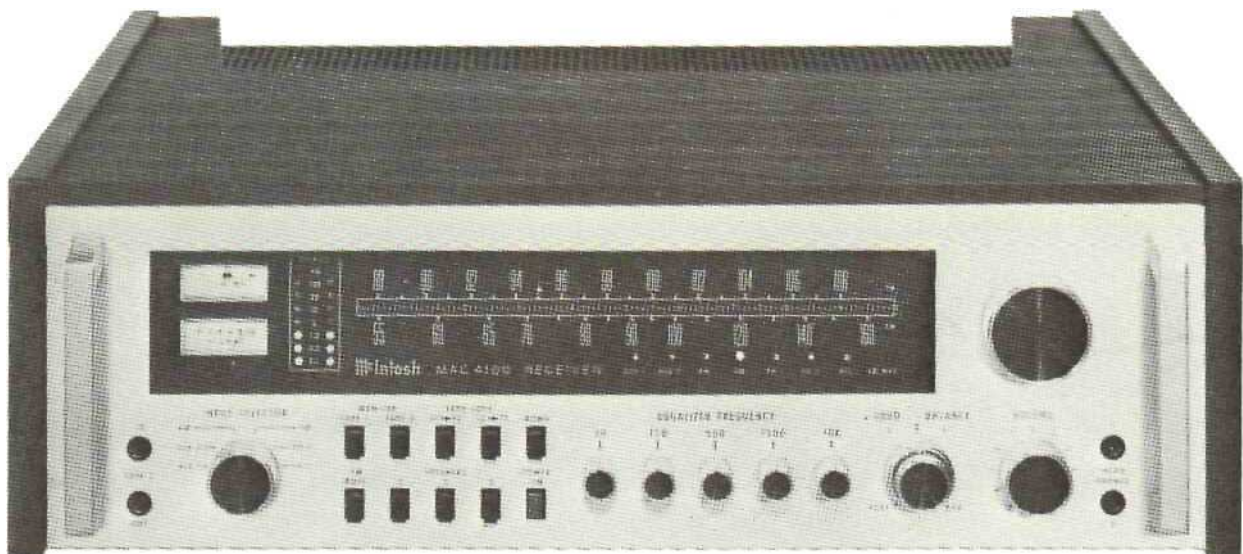

**VARIOUS REGULATORY AGENCIES REQUIRE THAT WE BRING THE FOLLOWING INFORMATION TO YOUR ATTENTION. PLEASE READ IT CAREFULLY.**

**WARNING: TO PREVENT FIRE OR SHOCK HAZARD, DO NOT EXPOSE THIS UNIT TO RAIN OR MOISTURE.**

The McIntosh you have purchased is a Model MAC 4100. It has a serial number located on the rear panel of the chassis. Record that serial number here:

Serial Number

The model, serial number and purchase date are important to you for any future service. Record the purchase date here:

Purchase Date

Upon application, McIntosh Laboratory provides a Three-Year Service Contract. Your McIntosh authorized Service Agency can expedite repairs when you provide the Service Contract with the instrument for repair. To assist, record your Service Contract number here:

Service Contract Number

Your MAC 4100 Solid State AM-FM/FM Stereo Receiver will give you many years of pleasant and satisfactory performance. If you have any questions, please contact:

## CUSTOMER SERVICE

McIntosh Laboratory Inc.  
2 Chambers Street  
Binghamton, New York 13903  
Phone: 607-723-3512

Take Advantage of 3 years  
of Contract Service ...  
Fill in the Application NOW.

# Contents

INTRODUCTION ...	2
INSTALLATION..	3
HOW TO CONNECT...	5
WHAT THE FRONT PANEL CONTROLS DO AND HOW TO USE THEM..	10
PUSHBUTTONS ...	10
FRONT PANEL INDICATORS . . .	12
BALANCING YOUR STEREO . . .	13
LISTENING TO YOUR STEREO . . .	13
MAC 4100 PERFORMANCE LIMITS ...	15
TECHNICAL DESCRIPTION . . .	16
PERFORMANCE CHARTS...20,21,22,23 BLOCK DIAGRAM...	24

## MCINTOSH THREE YEAR SERVICE CONTRACT

An application for a THREE YEAR SERVICE CONTRACT is included with this manual.

The terms of the contract are:

1. McIntosh will provide all parts, materials and labor needed to return the measured performance of the instrument to the original performance limits. The CONTRACT does not cover any shipping costs to and from the authorized service agency or the factory.
2. Any McIntosh authorized service agency will repair McIntosh instruments at normal service rates. To receive service under the terms of the SERVICE CONTRACT, the SERVICE CONTRACT CERTIFICATE must be presented when the instrument is taken to the service agency.
3. Always have service done by a McIntosh authorized service agency. If the instrument is modified or damaged, as a result of unauthorized repair the SERVICE CONTRACT will be cancelled. Damage by improper use or mishandling is not covered by the SERVICE CONTRACT.
4. The SERVICE CONTRACT is issued to you as the original purchaser. To protect you from misrepresentation this contract cannot be transferred to a second owner.
5. For your protection McIntosh selects only dealers who have technical competence to guide purchasers fairly, and provide service when necessary. To receive the SERVICE CONTRACT your purchase must be made from a McIntosh franchised dealer.
6. Your completely filled in application for a SERVICE CONTRACT must be post-marked within 30 days of the date of purchase of the instrument.
7. To receive the SERVICE CONTRACT all information on the application must be filled in. The SERVICE CONTRACT will be issued when the completely filled in application is received at McIntosh Laboratory Incorporated in Binghamton, New York.

# Introduction

The McIntosh MAC 4100 is a high quality, high power AM/FM Stereo Receiver. Its design has been governed by insistence on great flexibility, sensitivity, high performance with long life. It is easy to use.

Some of the many new improvements designed for your listening enjoyment Include:

Low noise field effect transistor analog input switching that keeps signal leads short to reduce possible noise and hum pickup. Mechanical contact noise is also eliminated.

LED Input indicators show which source has been selected and help make input selection faster, easier, surer and more convenient.

New low impedance transistor technology reduces hum and noise interference in the phono preamplifier.

Electronically controlled trimming of the precision stepped volume control maintains a channel to channel accuracy of 1 dB. This high order of exactness assures continuing program balance as the listening loudness is changed.

The five band program equalizer permits the adjustment and improvement of the tone contrast of the five most important listening ranges. Each can be emphasized or de-emphasized to satisfy your taste or listening atmosphere without affecting any of the other ranges.

The high quality power performance is con-

tinuously assured by POWER GUARD. The POWER GUARD circuit dynamically prevents power amplifiers from being overdriven into hard clipping -- which protects your speakers from potential damage -- which assures that the amplifier will produce its maximum output without increased distortion. The power delivered is 100 watts per channel at 4 ohms to give extra dynamic life to your music • even when you're using any combination of 3 sets of stereo loudspeakers.

The selectively lighted dial pointer lights only the relevant part of the tuning indicator to make tuning easier.

Automatic AC power control is provided by the auto On/Off circuit that conveniently shuts off the entire system when the turntable shuts off. No need to interrupt your pleasure at the end of the record.

Front panel tape recorder jacks allow simple plug In of an "outboard" tape recorder without upsetting your regular system connections.

Copies of tapes can be easily made between two connected tape recorders. Front panel tape copying controls function without disturbing other sound sources.

This outstanding receiver will serve you best when you understand its functions and what it is designed to do. Some time invested with this manual will be valuable in your knowledge of how it works.



x 8" [20.32 cm], [see Fig. 2]. In addition, a single 3/8" to 1/2" [1 cm to 1.3 cm] screw hole [see Fig. 2 and Fig. 3] must be drilled in the shelf to secure the receiver after installation. The top of the shelf must be attached flush with the bottom of the custom panel cutout.

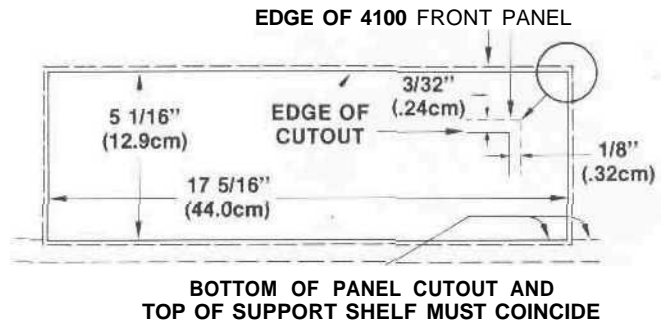

Fig. 1 Custom Cabinet Front Panel Cutout.

Prepare the MAC 4100 for custom mounting by removing the wood cabinet and feet as follows:

1. Remove 4 screws "A" [see Fig. 4]; two from each side panel.
2. To remove the enclosure top panel, the receiver's metal top must be temporarily removed. It is attached to the chassis by 4 screws "B" [see Fig. 4] installed 2 through the flange on the back and 1 through each of the flanges on the side. Remove these 4 screws. Save the screws to reinstall the metal top after removal of the enclosure top panel.
3. Under the metal top are 5 screws "C" that hold the enclosure top panel to the metal top [see Fig. 4]. Remove the 5 screws "C" that hold the metal top to the enclosure top panel.
4. Replace the metal top on the MAC 4100 with the 4 screws "B".
5. On the bottom of the receiver are the 4 plastic feet held on by screws "D" [see Fig. 4]. Remove these feet. Do not attempt to remove the 4 plastic button glides as these rest against the shelf, (see Fig. 2 and 3). At this point the receiver is ready to be custom installed.

From the front of the cabinet, thread the power cord through the opening in the cabinet panel and slide the MAC 4100 in on the shelf. Adjust the position to evenly cover the custom panel cutout. Lock the unit in place with a screw and washer inserted through the drilled hole in the mounting shelf [see Fig. 3]. Use a 1-1/4" [3.2 cm] screw for 1/2" [1.3 cm] shelf or a 1-1/2" [3.8 cm] screw for 3/4 [1.9 cm] shelf. Do not use longer screws.

The MAC 4100 may be used on a shelf or table top in the enclosure in which it comes or may be installed in a custom cabinet. In any method of use provide adequate ventilation.

The trouble-free life of an electronic instrument is greatly extended by providing sufficient ventilation to prevent the build-up of high internal temperatures that cause deterioration. Allow enough clearance so that cool air can enter at the bottom of the receiver and be exhausted from the top and rear. With adequate ventilation the instrument can be mounted in any position.

The MAC 4100 is installed from the front of a custom cabinet. The desirable space behind the cabinet panel is 15" [38.1 cm] deep, 18-1/2" [47 cm] wide, and 6"-[15.2 cm] high. The unit fits an opening exactly 5-1/16" [12.9 cm] by 17-5/16" [44 cm] wide. Make this cutout carefully. The receiver's front panel has a 1/8" [.32 cm] overhang on both sides and a 3/32" (.24 cm) overhang on the top and bottom, [see Fig. 1].

The weight of the receiver must rest on a shelf in which there is a ventilation hole cutout 15" [38-1 cm]

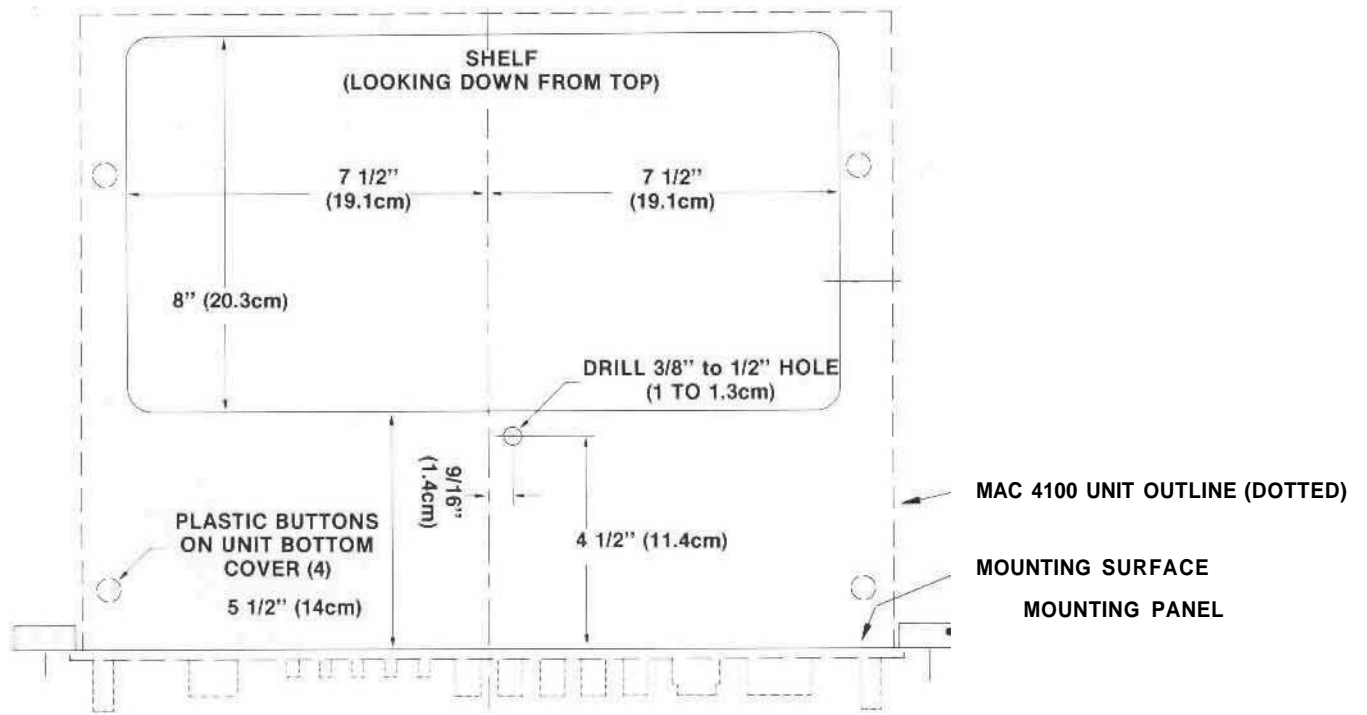

Fig. 2 Custom Cabinet Shelf Mounting Cutout.

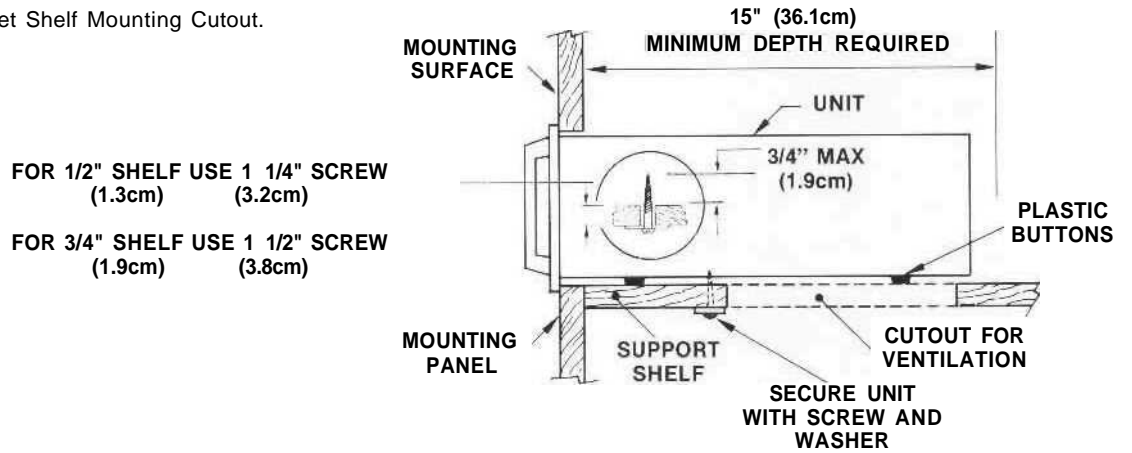

Fig. 3 MAC 4100 Custom Mounting Profile

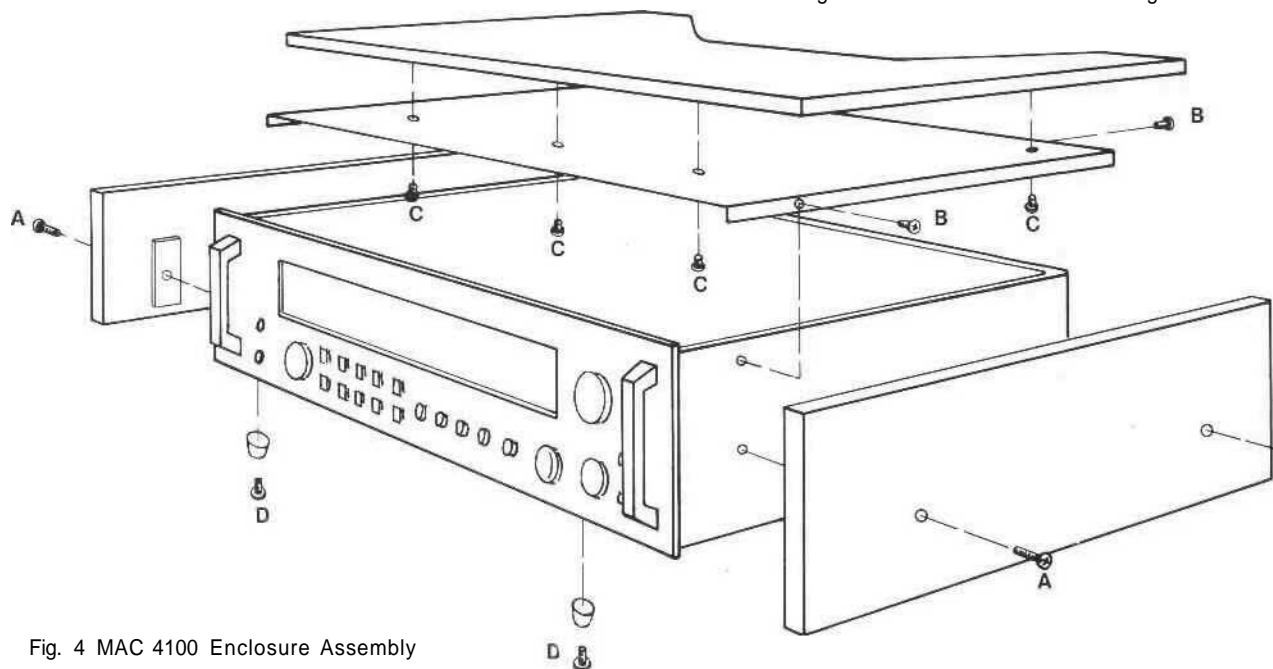
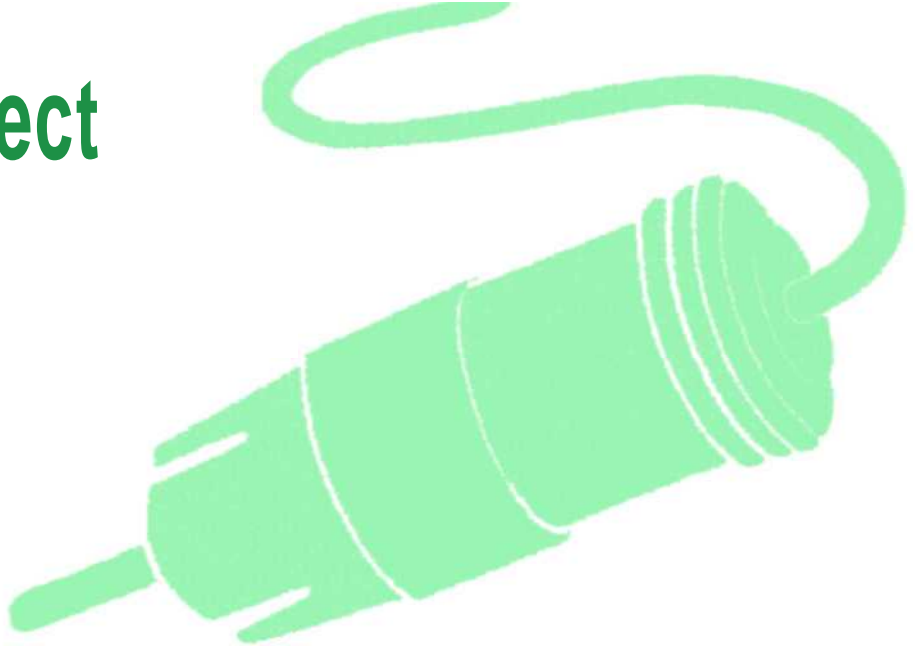

Fig. 4 MAC 4100 Enclosure Assembly

# How to Connect



## CONNECTING TURNTABLES

The MAC 4100 has shorting plugs in the phono inputs. To prevent unwanted noise remove only the shorting plugs from input jacks that are to be used. Connect the cable from the left channel of the turntable into the INPUT L PHONO 1 jack.

Connect the cable from the right channel of the turntable into the INPUT R PHONO 1 jack. Connect PHONO 2 in the same way for use with a second turntable.

## CONNECTING TAPE RECORDERS

### To Record

Connect a cable from the RECORDER L TAPE 1 OUT jack to the left high level input of the tape recorder. Connect a cable from the RECORDER R TAPE 1 OUT jack to the right high level input of the tape recorder. Connect a second recorder in the same manner to the RECORDER TAPE 2 OUT jacks.

### To Playback/Monitor.

Connect a cable from the left channel output of a tape recorder to the RECORDER L TAPE 1 IN jack. Connect a cable from the right channel output of a tape recorder to the RECORDER R TAPE 1 IN jack. Connect a second recorder in the same manner to the RECORDER TAPE 2 IN jacks.

### Front Panel Tape Recorder Jacks:

Tape recorder inputs and outputs are available at the TAPE IN-OUT jacks on the front panel left of the INPUT SELECTOR switch. Rapid, temporary connections to TAPE 2 facilities are easily made without getting at the rear panel. A metal shielded 1/4" stereo phone plug is used. Connections are tip: left signal, ring: right signal, and sleeve: common ground.

When a tape recorder is plugged into the front jacks all the facilities normally associated with TAPE 2 on the rear panel are automatically transferred to the front panel jacks.

## CONNECTING AC POWER

**The receiver AC power cord is plugged into a 120 volt 60 Hz wall outlet.**

There are three types of AC power outlets on the back panel of the MAC 4100: one red, two black, and two green.

The red and the green AC power outlets are on at all times. The red outlet can be used for a tape recorder with its own AC power switch. Plug the AC power cables from the turntable into the green TURNTABLE power outlets on the rear panel.

The two black outlets are switched on and off when the receiver is turned on or off. These are intended for equalizers and other accessories.

The POWER ON pushbutton shares AC power control, with the AC power switch on a turntable, through a current detecting switch circuit. On the rear panel the TURNTABLE AUTO/MANUAL switch selects the mode of operation.

When the switch is in the AUTO position and a turntable plugged into one of the green AC power outlets, the AC power to the receiver and to the black AC power outlets can be controlled by the turntable on/off switch. When AC power to the turntable is turned on, automatically the receiver and the SWITCHED black AC power outlets are turned on. The system will remain on until the turntable is turned off. The POWER ON pushbutton controls the AC power for any source other than the turntable.

In the MANUAL position only the POWER ON pushbutton will turn AC power on or off.

Some turntables have electronic circuits that draw current all the time. To use these turntables the AUTO/MANUAL switch must be in the MANUAL position. With the AUTO/MANUAL switch in the MANUAL position, AC power to the system will be controlled by the front panel POWER pushbutton only.

The green AC power outlets are protected with a one amp fuse. Any increase in the value of this fuse will affect the protection of the sensing circuit and may cause damage.

### **CONNECTING PROGRAM SOURCE GROUNDS**

A single GROUND post is provided to which grounds for turntables, record changers, tape decks, etc. are connected. To prevent hum pickup, the left and right program cables and the ground wire from that source should be wound or twisted together. Make sure the ground wire does not make any connection to the shields of the left and right program cables between the source and the input of the MAC 4100.

### **FMPRESELECTORSWITCH**

FM receivers can be overloaded by very large antenna input signals when the receiver is located very near to a FM broadcasting station or when a high gain directional antenna is used in a metropolitan area.

The preselector may be switched into or out of the FM RF circuit by a slide switch located on the MAC 4100 rear panel near the AM antenna.

We recommend that the FM Preselector switch be used in the "out" position for all FM listening conditions except where there is evidence of overload by strong stations. In that case, the "in" position will immunize against overload. For most stations there will be no listening difference between the two switch positions.

MAC 4100 receivers with serial numbers below BY3000 do not have the FM preselector switch described above.

### **CONNECTING AN FM ANTENNA**

One of three antenna systems can be used: [1] an outdoor FM antenna, or [2] a VHF-TV antenna, or [3] the indoor dipole supplied.

An outdoor antenna is recommended for optimum performance in all areas. In fringe [outlying] areas, best results will be obtained with a highly directional FM antenna used in conjunction with a rotator. If the antenna uses a 300 ohm lead, connect it to the ANTENNA 3000 FM push connectors.

The coaxial cable of an unbalanced 75 ohm antenna connects to the rear panel ANTENNA 750 FM type F coaxial connector.

An outside antenna system should not be located in the vicinity of overhead power lines or other electric light or power circuits, or where it can fall into such power lines or circuits. When installing an outside antenna system, extreme care should be taken to keep from touching such power lines or circuits as contact with them might be fatal.

A VHF-TV antenna can be effective when it is designed for both FM and TV reception. Connect the two leads from the VHF-TV antenna to the ANTENNA 300WFM push connectors.

### **CONNECTING AN INDOOR DIPOLE ANTENNA**

The flexible folded dipole antenna [300 ohm] is for use in urban or high strength signal areas. Connect the two leads from the dipole to the ANTENNA 300W FM push connector.

The flexibility of the twin flat wire assembly permits it to be placed under a rug, tacked behind the stereo ... or placed in any other convenient location. In some cases, it may be necessary to "position" the antenna for best signal reception. This should be done before it is permanently located.

Avoid locating the antenna next to other wires or metal objects. Any indoor antenna may be ineffective in houses having metal siding or metal foil insulation.

### **AMANTENNA**

For local and most moderately distant AM reception the built-in ferrite loopstick antenna may be used. The AM loopstick antenna is on a swivel base and must be adjusted away from the chassis for best reception.

Distant reception can be improved with the use of a copper antenna wire 50 to 150 feet in length. Suspend the wire in a straight line as high as possible. Attach the wire at each end with suitable glass or ceramic insulators. Connect a lead-in wire at any convenient point on the antenna. It is recommended that a lightning arrester be used with an outdoor AM antenna. The arrester should be well grounded to a ground rod or cold water pipe.

### **CONNECTING A MAXIMUM PERFORMANCE INDICATOR**

The scope TP1 and TP2 jacks on the rear panel are used to connect a McIntosh maximum performance indicator or an oscilloscope. Follow directions outlined in the maximum performance indicator owner's manual.

### **FUSES**

A 4-amp SLO BLO fuse protects the receiver circuits. The fuse does not protect additional equipment connected to the rear panel AC power outlets. A one amp fuse protects the turntable auto on circuit. If this fuse opens, power to the green outlets will be interrupted.



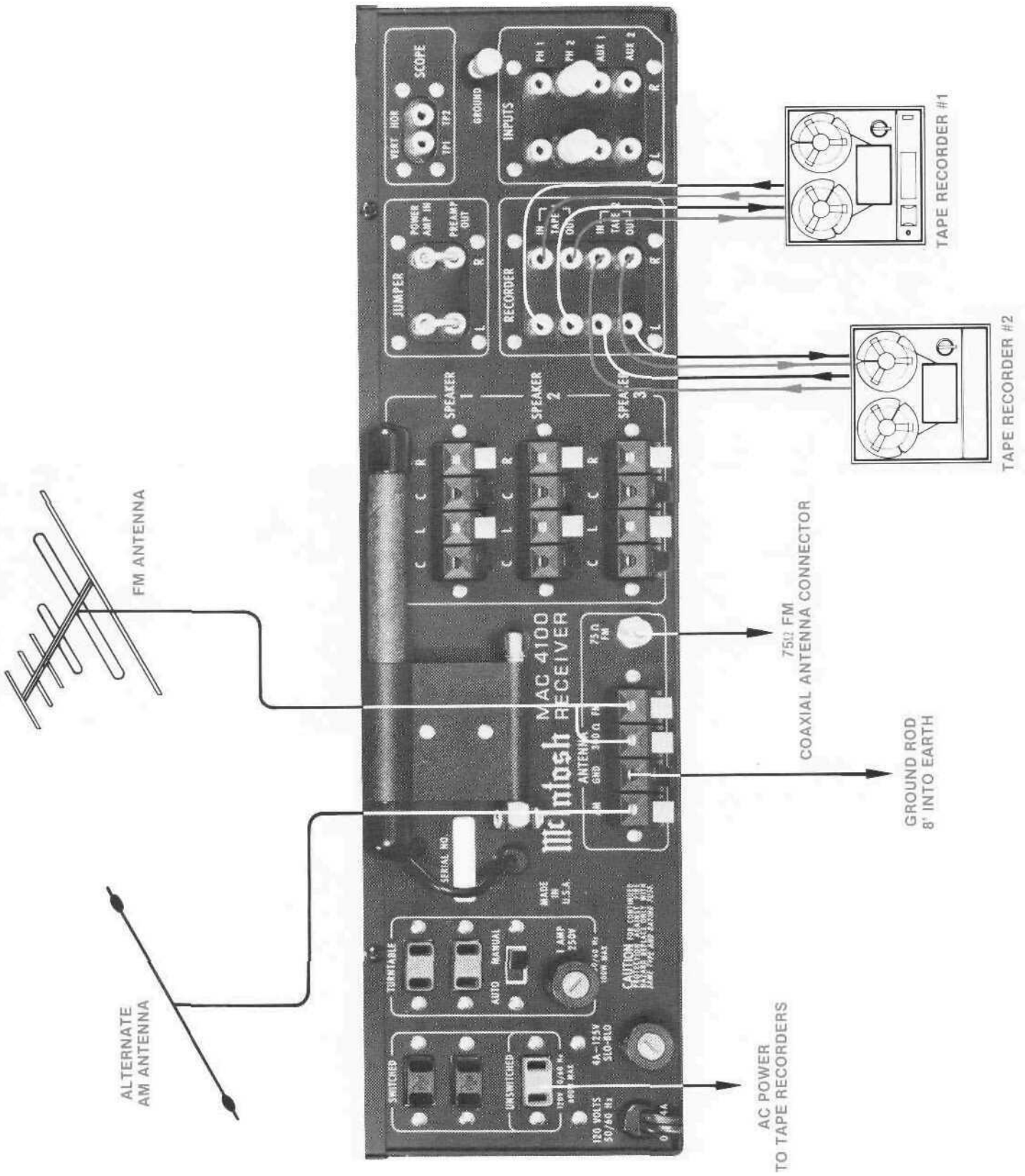

**CONNECTING LOUDSPEAKERS FOR STEREO**

All speakers are connected to the push connectors on the rear panel. When stereo speakers have been connected to the proper push connectors, the corresponding front panel pushbuttons turn the speakers on or off.

Selection of the proper gauge wire to connect the loudspeakers preserves the quality of sound reproduction for which the loudspeakers have been designed. If undersize wire is used, resistance is added to the receiver/loudspeaker combination which adversely affects the performance. Added resistance causes reduction of damping characteristics, modification of frequency response and reduction in power output.

Use lamp cord, bell wire, or wire with similar type of insulation to connect the speakers to the amplifier, in all cases, the leads to and from the speaker should be twin conductor or twisted together. When using 8 ohm speakers and for the normally short distances of under 30 feet between the amplifier and speaker. No. 18 wire or larger can be used. For distances over 30 feet between the receiver and speaker use larger diameter wire. Select the correct size wire for the wire length from the chart. It is recommended that the DC resistance of the speaker leads be less than 5% of the speaker impedance. Up to 10% can be tolerated. Resistance of the leads should be computed for the length of wire both to and from the speaker or speakers. The heavier gauge wires may not fit into the holes in the speaker and receiver terminals. Attach a short piece of lighter gauge wire and then connect to the terminals.

Wire Gauge	MAXIMUM WIRE LENGTHS			
	For 4 Ohm Load		For 8 Ohm Load	
	Feet	Meters	Feet	Meters
22	6	1.8	12	3.7
20	10	3.1	20	6.1
18	15	4.6	30	9.1
16	25	7.6	50	15.2
14	40	12.2	80	24.4
12	60	18.3	120	36.6
10	100	30.5	200	66.0

Wire lengths above represent the wire resistance equal to 5% of the speaker impedance

For multiple speaker operation, run separate leads from the receiver to the speakers.

Connect the leads from the left main loudspeaker to the SPEAKER 1 Left and Common push connectors. Connect the lead from the right main

loudspeaker to the SPEAKER 1 Right and Common push connectors. Connect the leads from a second left loudspeaker to the SPEAKER 2 Left and Common push connectors. Connect the lead from a second right loudspeaker to the SPEAKER 2 Right and Common push connectors. Connect the leads from a third left loudspeaker to the SPEAKER 3 Left and Common push connectors. Connect the lead from a third right loudspeaker to the SPEAKER 3 Right and Common push connectors.

**CONNECTING ONE LOUDSPEAKER FOR MONO**

The left and right outputs of the MAC 4100 must connect to separate loudspeakers. Do not parallel the output connections for a single loudspeaker. If the left and right outputs are connected together excessive heat is generated in the power amplifiers which causes damage even though the MODE SELECTOR pushbutton is in the MONO position. If you wish to drive a single loudspeaker, put the MODE SELECTOR in MONO and connect the loudspeaker to the left or the right speaker push connectors only. It is not necessary to connect a load to the other channel output.

**CONNECTING A MCINTOSH EQUALIZER**

On the JUMPER panel, remove the jumpers between the PREAMP OUT jacks and POWER AMP input jacks. The environmental equalizer is connected between these jacks. Standard shield cables connect the PREAMP OUT to the input of the equalizer. Connect the output of the equalizer to the POWER AMP Input jack.

**CONNECTING OTHER POWER AMPLIFIERS**

External power amplifiers may be fed to the MAC 4100 in two ways:

1. Fed from the RECORDER TAPE OUT. The output at this point is not affected by the volume or equalizing controls of the MAC 4100. Use this output to drive an amplifier which has its own controls. A possible use would be to operate an independent system in a remote location where volume requirements need to be locally controlled.
2. Fed from the AMPLIFIER - PREAMP OUT jacks. The output at these jacks is affected by the VOLUME, EQUALIZER, BALANCE, and LOUDNESS controls. Use this connection to drive an amplifier without controls of its own. or where the influence of the controls of the MAC 4100 are wanted on all loudspeakers.

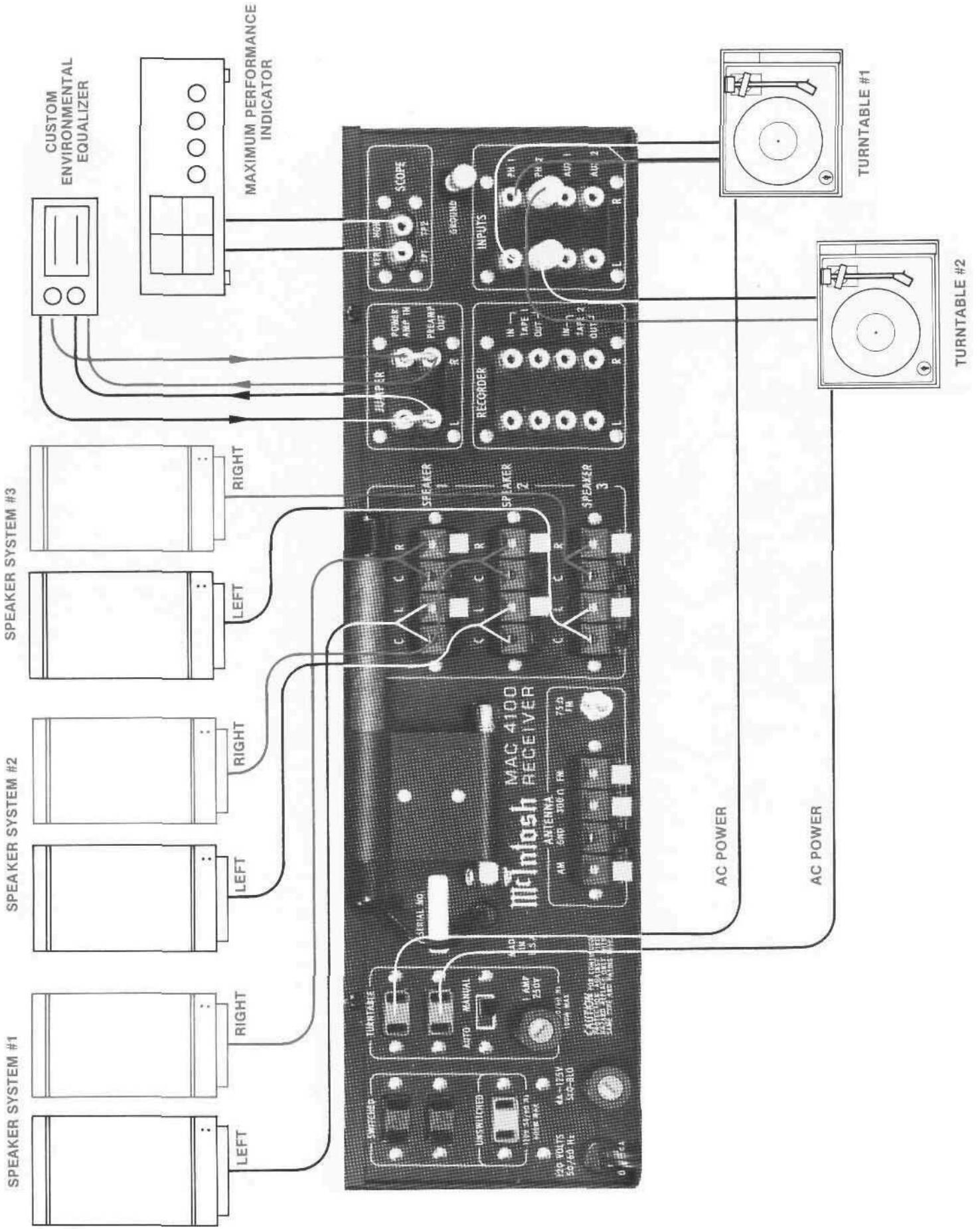

# What the Front Panel Controls do and How to use Them

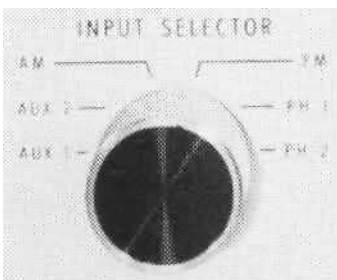

## INPUT SELECTOR

The six position INPUT SELECTOR controls DC voltage fed to FET analog switches which choose the input program selected. The INPUT SELECTOR is turned to:

**AUX 1:** to connect the output from any high level program source requiring flat amplification to the high level input stage. Such a source could be another tape recorder, a television set, etc. The input impedance is 100,000 ohms

**AUX 2:** same as AUX 1

**AM:** to connect the AM tuner circuits to the amplifiers and loudspeakers

**FM:** to connect the FM tuner circuits to the amplifiers and loudspeakers

**Phono 1:** to connect the output of magnetic phono cartridge plugged into PHono 1 to the low level amplifying stages. The response of these stages has been shaped to precisely conform to revised RIAA standards. The input impedance is 47,000 ohms, 87 pf

**Phono 2:** Same as PHono 1

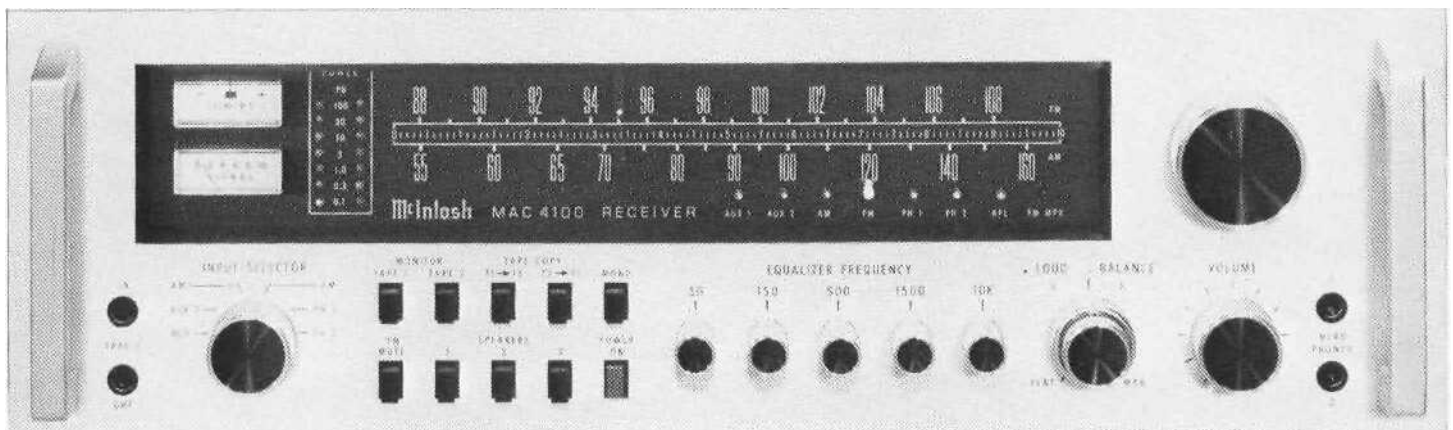

## Pushbuttons

**IMPORTANT:** When the MAC 4100 is operated with either MONITOR pushbutton at the in position, the program heard will be that from the tape recorders only. Signal from any other source will not be heard from the loudspeakers. To hear any other source, make sure the MONITOR pushbuttons are OUT.

The MONITOR switches are mechanically interlocked to prevent simultaneous monitoring from two tape recorders. If one button is at the in position, it must be pushed again to release it to the out position before the other button can be pushed.

The MAC 4100 is designed so it may be used with two tape recorders. The four upper left pushbuttons on the front panel control the signal output of these recorders. They permit playback of either recorder, monitor of either recorder as recordings are being made, or copying of tapes from one recorder to another while listening to a separate program.

**MONITOR TAPE 1 pushbutton out:** The program source as selected by the INPUT SELECTOR is fed to the power amplifiers and heard through the loudspeakers; pushbutton in: Signal from a tape recorder plugged into TAPE 1 IN is fed to the power amplifiers and heard through the loudspeakers.

**MONITOR TAPE 2 pushbutton:** Functions similarly to monitor Tape 1. It also controls the program from a tape recorder plugged into the front panel TAPE IN and OUT jacks. When a tape recorder is plugged into the front Jacks all the facilities normally fed to TAPE 2 on the rear panel are automatically transferred to the front panel. The tape recorder plugged into the TAPE 2 IN and OUT jacks on the rear panel is automatically disconnected.

**TAPE COPY T1 - T2 pushbutton in:** connects the output from tape recorder 1 to the input of tape recorder 2 without affecting the program being

heard from the speakers. In this position a copy of the program on tape recorder 1 can be made on tape recorder 2. To monitor the original use MONITOR TAPE 1 pushbutton and to monitor the copy use MONITOR TAPE 2 pushbutton.

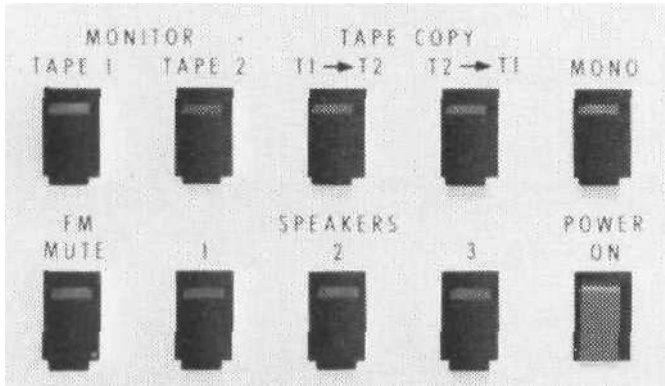

TAPE COPY T2 - T1 pushbutton in: connects the output from tape recorder 2 to the input of tape recorder 1 without affecting the program being heard from the speakers. In this position A copy of tape program on recorder 2 can be made on recorder 1. To monitor the original use MONITOR TAPE 2 pushbutton and to monitor the copy use MONITOR TAPE 1 pushbutton.

MONO: The MONO pushbutton switches the audio sections of the receiver from stereo mode to MONO. When the INPUT SELECTOR is in the FM position the FM multiplex light will remain on when tuned to a FM stereo station regardless of the position of the MONO pushbutton. The program heard will be mono. The TAPE OUT jacks are not affected by the MONO pushbutton.

FM MUTE: With the pushbutton in, interstation noise and weaker stations are suppressed; pushbutton out: noise between stations, as well as very weak stations, will be heard as you tune across the dial.

SPEAKERS 1, 2 and 3: When each of these pushbuttons is pushed in, a pair of loudspeakers is connected to the power amplifier outputs. Speaker 1, 2 and 3 may be selected one at a time, any combination or all at once.

POWER ON: The POWER ON pushbutton shares AC power control, through a current sensing switch circuit, with the AC power switch on a turntable. On the rear panel the TURNTABLE AUTO/MANUAL switch selects the mode of operation.

When the switch is in the AUTO position and a turntable is plugged into one of the green AC power outlets, the AC power to the receiver and to the black AC power outlets can be controlled by the turntable on/off switch. When AC power to the turntable is turned on, automatically the receiver and the SWITCHED black AC power outlets are turned on. The system will remain on until the turntable is turn-

ed off. The POWER ON pushbutton controls the AC power for any source other than the turntable.

In the MANUAL position only the POWER ON pushbutton will turn receiver AC power on or off.

## EQUALIZER FREQUENCY CONTROLS

Each of five EQUALIZER FREQUENCY controls modifies upward or downward the tone balance of a band of frequencies centered on the frequency marked above the control. The flat position of the control has a detent for easy reference. Each control provides 12 dB boost or cut at the specified center frequency.

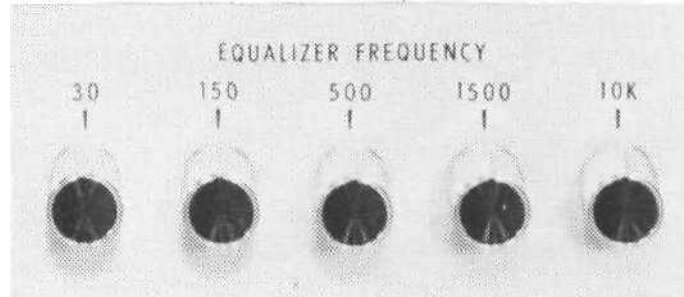

Use the EQUALIZER FREQUENCY controls to modify the sound and tone balance of program material. Here are some suggestions from which to start:

Problem	Equalizer Correction
Bass too weak	Raise 30 and/or 150
Male vocalist needs reinforcing	Raise 150
Female vocalist reinforcing	Raise 500
Hum on program	Reduce 30
Violins, trumpets dull	Raise 1500
Drum "brushes" not audible	Raise 10 K



## BALANCE and LOUDness

The BALANCE and LOUDness controls are concentric. The BALANCE control [large outer knob] adjusts for equal volume of either the left or right channels. The volume of the channels can be varied relative to each other without affecting their combined volume.

left... turning the control to the left accents the left channel by reducing the right channel output.

right... turning the control to the right accents the right channel by reducing the left channel output.

The LOUDness control [small center knob] increases both bass and treble frequencies of both channels as it is turned clockwise. Adjustment of the LOUDness control allows life-like frequency balance when playing music softly. Its contour is the

same, regardless of the position of the volume control. This contour is accurately modelled after the family of "Equal Loudness" curves identified by Fletcher and Munson.

The loudness circuitry is completely independent of the volume control. Therefore, any desired amount of compensation can be introduced regardless of volume control position.

**VOLUME CONTROL**

The VOLUME control is a precision step control manufactured for McIntosh Laboratory. It has 32 steps with a 70 dB range, plus volume off. Left and right channel tracking are within

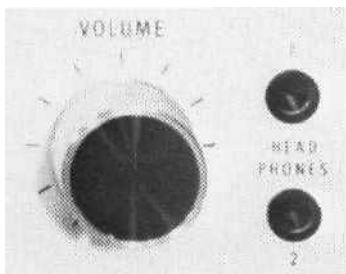

1 dB. This extreme accuracy is obtained through special electronically controlled resistance element trimming. Since the switch commutator touches only contact pads and not the precision resistor elements, tracking accuracy is permanently maintained and is noise free.

**HEADPHONE JACKS**

The front panel HEADPHONE jacks have been designed to feed low impedance dynamic headphones. Electrostatic headphones generally require higher power than dynamic headphones. They must be connected to the speaker push connectors on the rear panel.

Plug headphones into the front panel HEADPHONE jack. Adjust the front panel VOLUME control for comfortable headphone listening.

Signal to the headphone jacks is not affected by the SPEAKER switches.

# Front Panel indicators

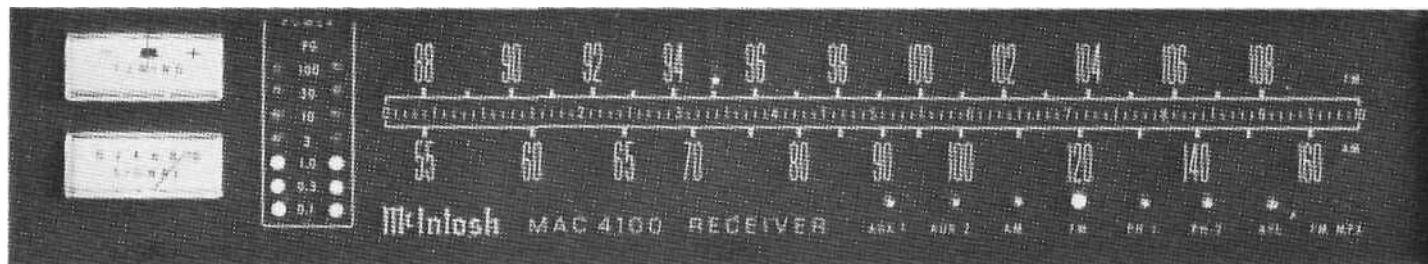

The MAC 4100 has three dial scales:

1. AM - marked 550 to 1600 kHz
2. FM - marked 88 to 108 MHz
3. Logging Scale - 0-100

As the tuning knob is turned, the tuning indicator moves across the dial. To make tuning easier only the portion of the indicator directly behind the appropriate dial scale is lighted. On FM, the upper portion of the indicator is lighted. On AM, the lower portion is lighted.

The logging scale can be used to accurately retune any station. You may find it easier to keep a record of your favorite stations by use of the logging scale.

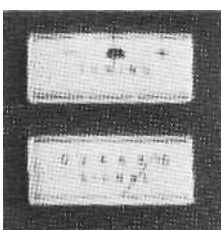

**FM TUNING METER**

An FM station is correctly tuned when the meter needle is in the black area of the FM tuning meter and the AFL indicator light is lighted.

**SIGNAL STRENGTH METER**

When tuning either an FM or AM signal the signal strength meter indicates the strength of the signal as received from the antenna. The higher the indication the stronger the signal.

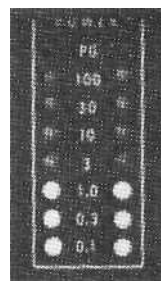

**AMPLIFIER POWER OUTPUT INDICATORS**

The amplifier POWER output indicators are to the left of the tuning dial. There are two vertical columns of seven yellow Light Emitting Diode [LED] indicators - the left column for the left channel and right column for the right channel.

As power to the loudspeakers is increased, more LEDs are turned on, vertically, indicating the increase. Each row is independent of the other. The LEDs provide constant and instant information on the amount of power being fed to your speakers.

**POWER GUARD**

POWER GUARD assures that the amplifier can not

be over driven so amplifier output clipping is eliminated. Clipping is caused when the amplifier is asked to produce more power output than it can deliver with low distortion. Amplifiers are capable of delivering large quantities of power when they are driven to clipping and can have more than 40% harmonic distortion. The extra energy content of the clipped signal will damage most speakers. A McIntosh advancement helps to protect your speaker from this kind of damage. The MAC 4100 has a built in "waveform comparator" that compares the wave shape of the input signal with the output signal. If the non-linearity between the two signals exceeds 0.5% the POWER GUARD circuit operates. Operation is indicated when the LEDs at the top of the amplifier power indicator are lighted in red. As long as the amplifier operates without overload the NORMAL indicator illuminates. With POWER GUARD operating the output waveform distortion is limited to 1 %.

## Balancing Your Stereo

The performance and enjoyment of a stereo system is greatly increased when the sound is properly balanced. The balance of the stereo system is affected by many things including room acoustics, furniture placement, room shape, small differences in loudspeakers etc. Factors that affect proper stereo balance are correct phase for both channels and equal program loudness.

### TO ADJUST PHASE

Press the MONO pushbutton. Turn the BALANCE control to 12 o'clock. Stand about ten feet in front of and midway between the loudspeakers. The sound should appear to come directly from in front of you.

## Listening to Your Stereo

### FOR ALL LISTENING

Set the "SPEAKERS" pushbuttons in for operation of the desired speakers. Set the monitor pushbuttons out except for tape listening. Turn on power by pressing the POWER ON button in.

### LISTENING TO A STEREO RECORD

Turn the INPUT SELECTOR to PHono 1 or PHono 2 whichever is connected to the turntable you wish to hear. Set the MONO pushbutton out for stereo. Adjust the VOLUME control to desired volume. Adjust

### INPUT INDICATORS

At the bottom right of the tuning dial area are eight LEDs, six indicate the status of the INPUT SELECTOR switch. The illuminated LED indicates the program source selected.



The two remaining LEDs indicate AFL and FM MPX. AFL indicates the operation of the automatic frequency lock circuit showing that the tuner is correctly tuned to the center frequency of the FM station.

FM MPX - indicates the FM station is broadcasting a 19 kHz pilot signal necessary for the transmission of FM stereo programs. It denotes the station is broadcasting stereo.

If the sound is not directly in front of you, reverse the leads on one of the loudspeakers only. When the sound comes from the midpoint between the speakers they are in phase.

### TO BALANCE LOUDNESS

Press the MONO pushbutton. Play a familiar recording. Turn the BALANCE control to the 12 o'clock position. While the program is playing stand between the two loudspeakers. Listen for a difference in loudness between speakers. If there is a difference in loudness, turn the BALANCE control toward the speaker that is not as loud. Adjust the BALANCE control until the sound is balanced between both speakers.

the LOUDness control for any desired compensation.

### LISTENING TO A MONOPHONIC RECORD

Push the MONO pushbutton in for MONO. Adjust the VOLUME control to desired volume. Adjust the LOUDness control to any desired compensation.

### LISTENING TO A STEREO TAPE RECORDER

Push in either MONITOR TAPE 1 or TAPE 2, whichever is connected to the tape recorder you

wish to hear. Set the MONO pushbutton out for stereo. Adjust the VOLUME to desired volume. Adjust the LOUDness control to any desired compensation.

#### **TAPE MONITORING**

To MONITOR the program being recorded, press the corresponding MONITOR TAPE pushbutton in.

A program being recorded may be monitored from the playback head of the tape recorder as the program is being recorded if the tape recorder has separate playback heads and associated preamplifiers.

A program may be modified with equalizer, balance and loudness controls before recording, by connecting the tape recorder inputs to the JUMPER PREAMP OUT jacks on the rear panel. All front panel controls, then, influence the output of the tape recorder. Note that once recording has started, adjustment of the controls will change the program to the tape recorder. In addition, the available signal output is much higher than the output available from the RECORDER TAPE OUT jacks. Be sure the signal does not overload the tape recorder input. To hear the program from the loudspeakers a "Y" connector must be used to join the tape recorder, the preamplifier output and power amplifier input.

#### **LISTENING TO AM**

Turn the INPUT SELECTOR to AM. Rotate the tuning knob so the station of your choice shows maximum deflection of the SIGNAL strength meter. Adjust the VOLUME to a comfortable level.

#### **LISTENING TO FM OR FM STEREO**

Turn the INPUT SELECTOR to FM. Set the MONO pushbutton in the stereo or out position. The MAC 4100 uses a McIntosh developed automatic mono/stereo switching circuit. The switching is electronic and switches smoothly and silently without clicks or transients. When the 19 kHz pilot signal for stereo transmission is received the automatic circuitry switches the MAC 4100 to stereo and the FM MPX LED indicator is turned on. If the FM station is not broadcasting a 19 kHz pilot signal the FM MPX Indicator will remain off and the tuner will automatically switch to mono.

Rotate the tuning knob to the station of your

choice. For most accurate fine tuning of the station, adjust the tuning knob until the AFL indicator lights; a sure indication that the station is exactly tuned and locked in. Adjust the VOLUME to a comfortable level. The FM muting circuit suppresses noise between stations. It also suppresses weaker stations not strong enough to override the background noise. Muting threshold, carefully adjusted to optimum at the factory, determines the strength of the signal which can be heard with muting in operation. While tuning you may notice the tuning indicator will show a station yet no program is heard from the loudspeakers. The muting circuit in the tuner has rejected the station because there is noise accompanying the weak signal. Push the FM MUTE pushbutton to the out position and the station will be heard. Most programs that can be tuned in this manner are of poor quality due to interfering noise.





# MAG 4100 Performance Limits

We promise you that the MAC 4100 you buy is capable of performance at or exceeding these limits at the time of purchase or you get your money back. McIntosh PERFORMANCE LIMITS are the maximum departure from performance perfection permitted for a McIntosh instrument.

## Performance

McIntosh audio power ratings are in accordance with the Federal Trade Commission Regulation of November 4, 1974 concerning power output claims for amplifiers used in home entertainment products.

### POWER OUTPUT

100 watts minimum sine wave continuous average power output, per channel, both channels operating into 4 ohms 20 Hz to 20 kHz, with no more than .05% total harmonic distortion.

75 watts minimum sine wave continuous average power output, per channel, both channels operating into 8 ohms 20 Hz to 20 kHz, with no more than .05% total harmonic distortion.

### OUTPUT LOAD IMPEDANCE

4 ohms, 8 ohms

### RATED POWER BAND

20 Hz to 20 kHz

### TOTAL HARMONIC DISTORTION

.05% maximum at any power level from 250 milliwatts to rated power per channel, 20 Hz to 20 kHz, both channels operating.

### INTERMODULATION DISTORTION

.05% maximum at any power level from 250 milliwatts to rated power-per channel both channels operating for any combination of frequencies 20 Hz to 20 kHz.

### FREQUENCY RESPONSE

20 Hz to 20 kHz +0, -0.5 dB at rated power

### HUM AND NOISE

**Power Amp:** 100 dB IHFA, 95 dB unweighted, below rated output

**Tape and Aux Input:** 95 dB IHFA, 90 dB unweighted, below rated output

**Phono Input:** 90 dB IHFA, 80 dB unweighted, below 10 mV input

### DAMPING FACTOR

Greater than 30

### INPUT SENSITIVITY AND IMPEDANCE

**Power Amp:** 2.5 V; 22,000 ohms

**Tape and Aux:** 250 mV; 100,000 ohms

**Phono:** 2 mV; 47,000 ohms; 87 pF

### TAPE OUTPUT

**Tuner:** 1.0 V at 100% modulation [FM]

**Tape:** 250 mV with rated input

**Phono:** 250 mV with rated input

### PROGRAM EQUALIZER

±12 dB at 30, 150, 500, 1500, and 10,000 Hz

## AM SECTION

### SENSITIVITY

75 µV IHF [External antenna]

### SIGNAL TO NOISE RATIO

45 dB minimum IHF, 55 dB at 100% modulation

### HARMONIC DISTORTION

1% maximum at 30% modulation

### FREQUENCY RESPONSE

3500 Hz @ -6 dB

### ADJACENT CHANNEL SELECTIVITY

30 dB minimum IHF

### IMAGE REJECTION

65 dB minimum, 540 kHz to 1600 kHz

## FM SECTION

### SENSITIVITY

2.5 µV [13 dB] IHF minimum

### SIGNAL TO NOISE RATIO

70 dB IHF minimum

### HARMONIC DISTORTION

Mono: 0.18% IHF maximum

Stereo: 0.38% IHF maximum

### FREQUENCY RESPONSE

20 Hz to 15kHz +0, -1 dB

### CAPTURE RATIO

1.8 dB

### SELECTIVITY

75 dB IHF minimum

### SPURIOUS REJECTION

90 dB IHF minimum

## IMAGEREJECTION

80 dB IHF minimum

## STEREO SEPARATION

45 dB minimum at 1 kHz

## SCA REJECTION

60 dB minimum

## GENERAL

### SEMICONDUCTOR COMPLEMENT

45 Transistors

31 Integrated Circuits

62 Diodes

1 Silicon Controlled Rectifier

## MECHANICAL INFORMATION

### SIZE:

In cabinet: 18-5/8 inches (473.1mm) wide, 6-1/2 inches (165.1mm) high, 15-1/2 inches (393.7mm) deep. Without cabinet: Front panel measures 17-9/16 inches (446.1mm) wide by 5-1/4 inches (133.4mm) high. Chassis measures 17-1/8 inches (435mm) wide by 4-15/16 inches (125.4mm) high by 13-1/2 inches (342.9mm) deep. Knob and handle clearance required is 1-1/16 inches (27mm) in front of the mounting surface.

### FINISH:

Front panel is clear anodized to produce a brushed satin - silver finish with black anodized trim. Cabinet is walnut grained vinyl

### WEIGHT:

42 pounds (19 kg) net

56 pounds (25.4 kg) in shipping carton

# Technical Description

Engineering direction dictated a receiver design governed by insistence on a preamplifier with excellent flexibility, a FM section with great sensitivity and high selectivity, an AM section whose performance maximizes reception capabilities and a high performance, high power stereo power amplifier. These values were achieved and they retain the McIntosh reputation of long life and reliability.

## FM SECTION

The radio frequency [RF section] houses the complete FM-RF front end and part of the AM-RF circuitry. A seven section variable capacitor is the heart of the RF section. Four sections of the variable capacitor are used for FM. The remaining three are used in the AM section. By interleaving the sections: AM/FM/AM/FM etc., spurious responses have been significantly reduced. The use of the latest state of the art MOS field effect transistors as well as a carefully designed variable tuning capacitor has provided a high degree of RF selectivity and excellent spurious response rejection. Image rejection and spurious responses have been brought to a minimum in the RF section. A dual insulated gate metal oxide silicon field effect transistor [MOS-FET] is used as the first RF amplifier. Each gate of the transistor is internally protected by zener diodes against incoming externally generated transients. Use of the MOS-FET greatly reduces cross modulation over a wider dynamic range. This dynamic range permits the input circuit to accept extremely strong signals without overload. The mixer has been designed to use another MOS-FET for high sensitivity, low cross modulation, and freedom from overload. Low temperature co-efficient components

are used in the FM local oscillator to prevent frequency drift. This assures that you are properly tuned to the station. For optimum signal transfer and lower distortion, a special matching transformer has been designed to interface the FM-RF to the FM-IF amplifier. This matching transformer improves phase linearity of the IF amplifier.

All of the RF circuits to the FM sections of the variable capacitor are encased in a metal module. Within the metal module each FM-RF section is separately shielded by metal partitions. This extreme shielding gives protection against radiation or interference.

Antenna connections for either 300 ohm twin lead transmission line or 75 ohm coaxial cable are provided on the rear panel. The normal input impedance of the RF amplifier is 75 ohms. Impedance match to 300 ohms is provided by a McIntosh designed balun transformer. Connections for a 300 ohm line are made with push type terminals that do not require the use of tools. For the 75 ohm input, a type F connector is provided.

The FM-IF section consists of five integrated circuits and four piezo-electric filters. They combine to give a total gain of over 140 dB. The signal is amplified ten million times. The response curve has nearly linear phase characteristics. The skirts of the response curve are very steep. The maximum width is 170 kHz at 3 dB and 500 kHz at 60 dB. The response is symmetrical each side of the center frequency. The filters are permanently sealed and never require adjustment and cannot drift nor vibrate out of adjustment. The exceptionally high gain of the five integrated circuits assures hard limiting at

very low levels of Input signal.

A Foster-Seeley discriminator has been designed to complement the integrated circuit IF section. The detected output of the discriminator is extremely low in distortion.

### **FM STEREO MULTIPLEX**

The heart of the multiplex section is a new third generation phase lock loop (PLL) stereo decoder integrated circuit (IC). This PLL IC incorporates two special systems, an automatic variable separation control circuit to reduce background noise when receiving weak stereo stations, and a tri-level digital waveform generation which eliminates interference from SCA signals and from the sidebands of adjacent channel FM signals.

The variable separation control is operated from the IF amplifier's signal strength detector system. A smooth transition is provided from mono to stereo or visa versa at weak signal levels to provide the optimum signal to noise ratio and best stereo separation for the prevailing signal conditions. The circuit operates only during stereo reception, It switches automatically to monaural if the 19 kHz pilot tone is absent.

In the PLL the internal oscillator operates at 228 kHz locked to the 19 kHz pilot tone. The 228 kHz feeds a 3 stage Johnson counter via a binary divider to generate a series of square waves. Suitably connected NAND gates and exclusive OR gates produce the tri-level drive waveform for the various demodulators in the circuit. The usual square waveforms have been replaced in the PLL and decoder sections by tri-level waveforms. These tri-level forms contain no harmonics which are multiples of 2 or 3. This eliminates frequency translation and detection of interference from the side-bands of adjacent stations since the third harmonic of the sub-carrier (114 kHz) is excluded and interference from SCA broadcasts since the third harmonic of the pilot tone (57 kHz) is excluded. Unwanted spurious audible components and phase jitter in the PLL with consequent intermodulation distortion are inherently eliminated by this technique.

Additional advantages of the phase locked loop stereo demodulation are the elimination of inductors to minimize drift, integral lamp driving capability to indicate the presence of the 19 kHz pilot carrier, excellent channel separation over the entire audio frequency range, extremely low distortion, low output impedance, and transient-free mono/stereo switching.

After multiplex detection, 19 kHz pilot and 38 kHz carrier suppression circuits are used to prevent tape recorder interference.

The FM muting circuit is unusual. It operates both by detecting ultrasonic noise and by sensing correct

tuning of the detector circuit. To 'un-mute' it is necessary for the signal to have an adequate signal-to-noise ratio and to be tuned to the center of the FM carrier. The MUTING circuit can be activated or defeated by the front panel muting pushbutton. The switching on and off of the audio signal is done with FET analog switches.

### **AM SECTION**

The AM-RF amplifier circuit includes a three section variable tuning capacitor in a metal enclosure. This three section variable capacitor is used for greater spurious rejection. The McIntosh AM RF amplifier circuit is unique. It has constant sensitivity, constant selectivity and high image rejection across the complete AM band. Ordinary AM-RF circuits cannot do all of this simultaneously. This design achieves equal sensitivity even down to the low end of the band. Spurious, image and intermediate frequency rejection are all superior. The same circuit delivers equal selectivity across the entire band. The McIntosh circuit is unique in a super heterodyne AM receiver. In addition, there is no loss of audio frequency response at the low end of the band. Another advantage of the McIntosh circuit is freedom from cross modulation and overloading by strong local stations. A high quality loopstick antenna is provided and can be rotated for maximum performance over 180 degrees. Each MAC 4100 loopstick is individually tuned for optimum performance. After tuning, the loopstick is sealed. This custom matching of the loopstick to the AM-RF front end maximizes the performance of the loop stick antenna.

A rear panel antenna connector is provided for connecting an external antenna if desired. To maintain the excellent image rejection and spurious cross modulation of the AM-RF amplifier, an autodyne circuit was used for the AM mixer. The AM-IF uses two double tuned IF transformers designed to obtain a high degree of selectivity yet allowing good audio fidelity. A 10 kHz active filter eliminates the whistle and irritating monkey chatter caused by an adjacent station. The frequency response of all stations is nearly flat from 20 Hz to 3,500 Hz then rolloff begins. Because of the active filter the 10 kHz whistle elements are down over 30 dB or one-thousandth of what they would be without a filter. The automatic volume control system was designed to prevent bursting or thumps when the AM is tuned through a strong signal. Distortion at low audio frequencies is minimizing by using a two-section filter instead of the conventional single section.

### **INPUT SELECTOR SWITCHING**

Low level, noise sensitive input selector switching is done electronically using field effect analog switches. The front panel selector simply switches small

amounts of DC which turn the FET analog switches off or on. The design eliminates degradation of frequency response and noise pickup from long signal paths necessary with conventional switching.

### **PHONO AMPLIFIER**

The phono amplifier uses a high technology integrated circuit operational amplifier. Its differential input stage has been optimized for low noise and low distortion performance. Open loop gain of this integrated circuit is 100,000- With high open loop gain a large amount of negative feedback can be used around the phono amplifier to further reduce noise and distortion. The feedback network also provides precision RIAA frequency compensation. The network uses 1% metal film resistors and 5% poly film capacitors. To achieve low noise performance it is essential that the feedback network be very low impedance. As a consequence, the preamplifier must be capable of operating as a power amplifier to drive this impedance. The actual power output capability of this preamplifier stage is more than 100 milliwatts, a great margin beyond that which is required.

Input sensitivity of the phono amplifier is 2 millivolts. The gain of the amplifier is 42 dB at 1000 Hz. The phono amplifier has a very wide dynamic range. At 1000 Hz the phono input circuit will accept 100 millivolts without overload, a voltage far greater than the output of any current magnetic phono cartridge. Phono input overload therefore is virtually impossible. A signal level of 10 millivolts at the phono input at 1000 Hz will produce 1.2 volts at the tape output. The tape output has a source impedance of 200 ohms, designed to operate into a load impedance of 47,000 ohms or greater.

### **HIGH LEVEL AMPLIFIER**

At the input to the high level or loudness amplifier the signal passes through the MONO/stereo switch, then through the volume control, and into the amplifier. In the past loudness controls have typically used simple passive circuits connected to a tap on the volume control. As a consequence, compensation accuracy was dependent on many variables such as volume control position and differences in input level. The MAC 4100 uses active circuitry. The same type of integrated circuit operational amplifier that is used in the phono amplifier is used here. It has two feedback loops. One feedback loop is flat. The other feedback loop conforms to the Fletcher-Munson equal loudness compensation. A potentiometer is placed between these two feedback loops making it possible to select any combination of the two from a flat response to full loudness compensation. The overall gain of the stage is 20 dB and is not affected by the position of the loudness control.

### **EQUALIZER AMPLIFIER**

The equalizer amplifier uses high technology integrated circuit operational amplifiers. Its output stage has been optimized for the best transient performance and minimum distortion. Five other operational amplifiers are each arranged in a circuit configuration that are the equivalent of series tuned circuits, one at each of the five center frequencies. Each series tuned circuit is inserted via the control potentiometer in either the input circuit or feedback circuit of the operational amplifier thereby providing a boost and cut capability of 12 dB for each band of frequencies.

### **POWER AMPLIFIER**

The input impedance of the power amplifier is 22,000 ohms. It requires 2.5 volts RMS to drive the amplifier to rated output. At the input of the power amplifier two transistors are connected as a differential amplifier. The two input signals to the differential pair are the input signal and the negative feedback signal from the power amplifier. The differential amplifier permits the best use of negative feedback to maintain low noise and low distortion performance. The outputs of the differential amplifier are combined in a current mirror to a single output. This combined signal feeds a linear voltage amplifier which in turn drives two medium power driver transistors. The driver transistors feed the output stages. The output section is arranged as a fully complementary direct coupled series push/pull amplifier. The power transistors used in the output circuit are selected for their high power dissipation capability, wide frequency response, and large safe operating area. The power transistors are mounted on large black anodized heat sinks to assure that under normal operating conditions the transistors will operate at a low temperature. If operating temperatures should increase due to a shorted speaker or restricted ventilation, an automatic sensing device turns the speaker circuit off. The speaker circuit will turn on again when the temperature has returned to its normal limits. This additional protection assures you of reliability even under the most extreme operating conditions. To further insure reliability a special power output SENTRY MONITORING CIRCUIT prevents failure of the power amplifier transistors due to excessive mismatch or shorting of the output. When the MAC 4100 operates normally the SENTRY MONITORING CIRCUIT has no effect on signals passing through the power amplifier. If the power dissipation in the output transistors should rise above normal design limits the SENTRY MONITORING CIRCUIT restricts the drive to the output stage which reduces the dissipation in the output transistors. The SENTRY MONITORING CIRCUIT acts instantaneously for any input signal or load combination. This arrangement assures circuit reliability. Only McIntosh gives you this degree of protection.

The direct coupled complementary amplifier circuit holds the output at DC ground potential which eliminates the need for an output coupling capacitor. The available low frequency power output is restricted in competitive circuits that do require a coupling capacitor. The MAC 4100 power amplifier is direct coupled to insure maximum low frequency performance. In most direct coupled circuits, failure of any transistor in the power amplifier will cause a DC potential to appear in the output. To assure that no damaging or interfering DC appears across the output terminals, a special, very fast acting protector circuit constantly monitors the output circuit for DC. If, at any time, a constant DC level appears, the speakers are disconnected. The protective circuit reacts in milliseconds. Speakers remain disconnected until the cause has been fixed. Under normal operating conditions the protective circuit has no affect on the operation of the output circuit. This is another example of McIntosh continuous protection.

#### POWER GUARD

Amplifiers are capable of delivering large quantities of power when they are driven to clipping. Clipping is caused when the amplifier is asked to produce more power output than it can deliver with low distortion. A clipped amplifier can have more than 40% harmonic distortion. The extra energy content of the clipped signal will damage most loudspeakers, particularly delicate high frequency tweeters. A new McIntosh advancement helps protect your speakers from this kind of damage. The MAC 4100 has a built-in waveform comparator which compares the wave shape of the input signal with the output signal. If the disparity between the two signals exceeds 0.5% [equivalent to 0.5% total harmonic distortion] a front panel signal illuminates in red at the top of the power output indicators. With any further increase in distortion the POWER GUARD circuit will operate. This circuit limits the input dynamically so that the amplifier cannot be overdriven. POWER GUARD eliminates amplifier output clipping.

POWER GUARD does not limit the dynamic range or the power output of the power amplifier. Clipping occurs when an amplifier is asked to exceed its design limits and the capacity of the power supply. Since POWER GUARD does not begin to work until this point is reached, the power capability of the amplifier is never affected.

#### TURN ON DELAY

The MAC 4100 has transient-free turn on and turn off characteristics. A heavy duty relay, time-controlled by a transistor switch, connects the output to the speakers. The control to the transistor switch is derived from a long time constant capacitor charging network that turns the relay on approximately two seconds after the power switch is turned on. The same circuit has a short turnoff time constant and the relay drops out before the receiver's main power supply has a chance to discharge.

#### POWER SUPPLY

Two high current power supplies - a positive 48 volt and a negative 48 volt DC - are used to drive the output power amplifier. Very large filter capacitors, 12,000 microfarads each, are used to store a large amount of energy to provide good filtering and excellent voltage regulation. Good low frequency response and negligible low frequency distortion in the power amplifier stages depends on the regulation of the power supply.

Three additional electronically regulated power supplies are used in the MAC 4100; a + 12 volt supply for the FM front end, and a + 18 volt supply and a -18 volt supply for all operational amplifiers and the remainder of the circuits. Electronic regulation reduces noise and avoids tuner drift due to power line voltage changes.



# Performance Charts

POWER OUTPUT SECTION  
HARMONIC DISTORTION VS POWER  
RL = 8 OHMS, BOTH CHANNELS OPERATING

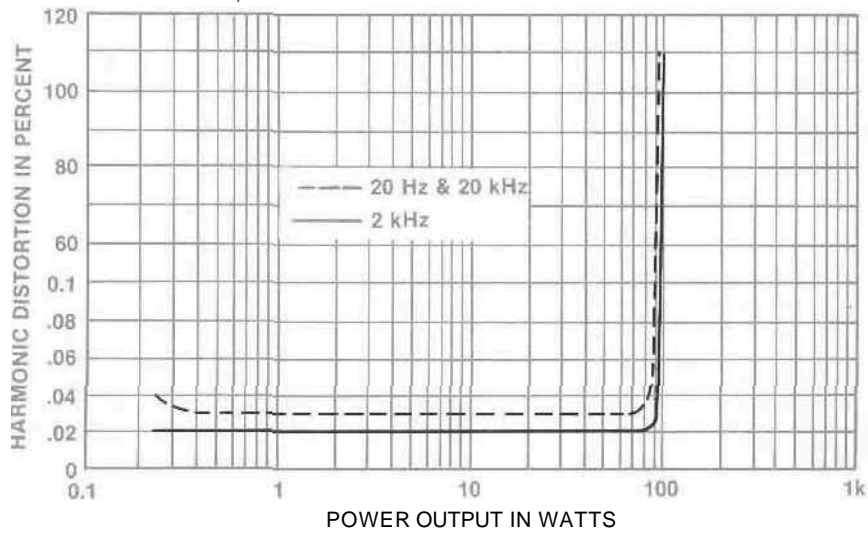

POWER OUTPUT SECTION  
BOTH CHANNELS OPERATING  
.05% THD POWER BANDWIDTH

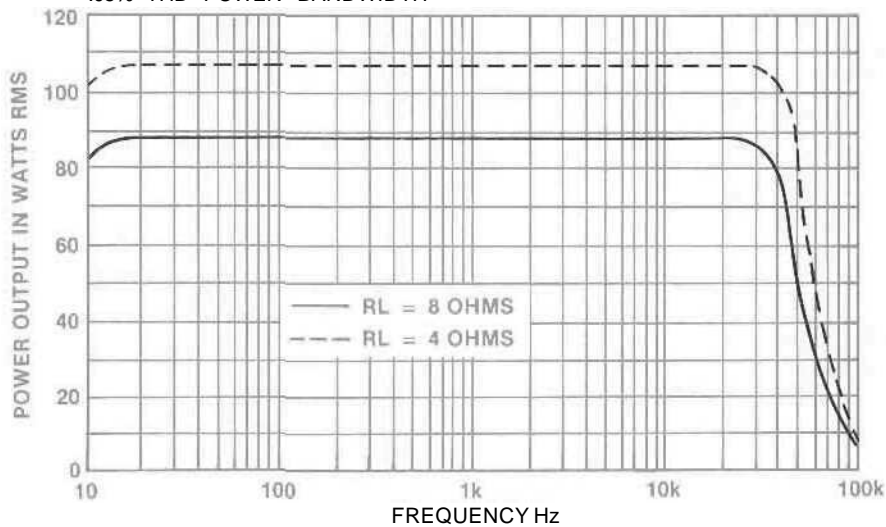

INTERMODULATION DISTORTION  
vs.  
POWER OUTPUT  
8 OHM OUTPUT  
INPUT FREQUENCIES 60 Hz AND 7 kHz  
INPUT RATIO: 4:1

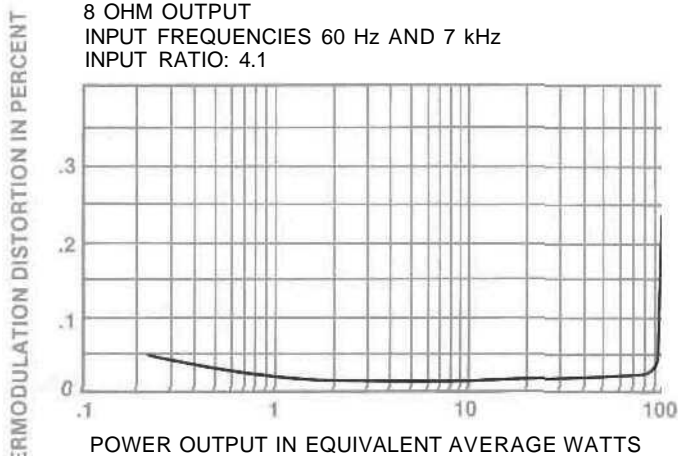

OUTPUT SIGNAL WAVEFORM SHOWING ACTION  
OF POWER GUARD TO ELIMINATE OUTPUT SIGNAL  
CLIPPING. AMPLIFIER INPUT IS OVERDRIVEN BY  
20 dB FOR BOTH OSCILLOGRAM TRACES.

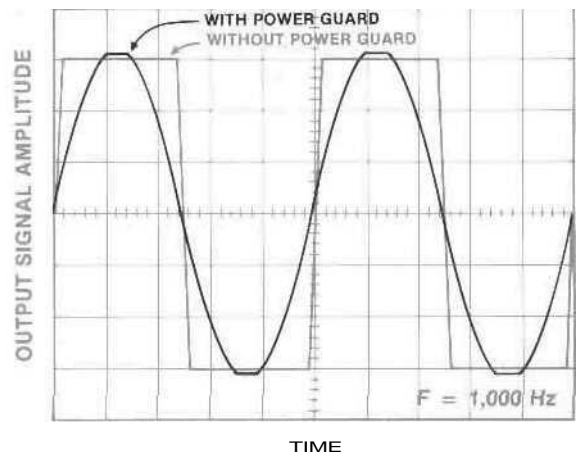

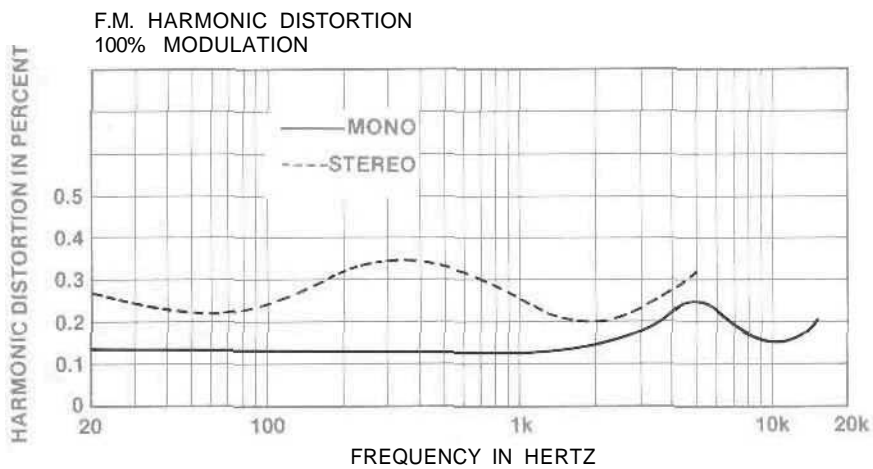
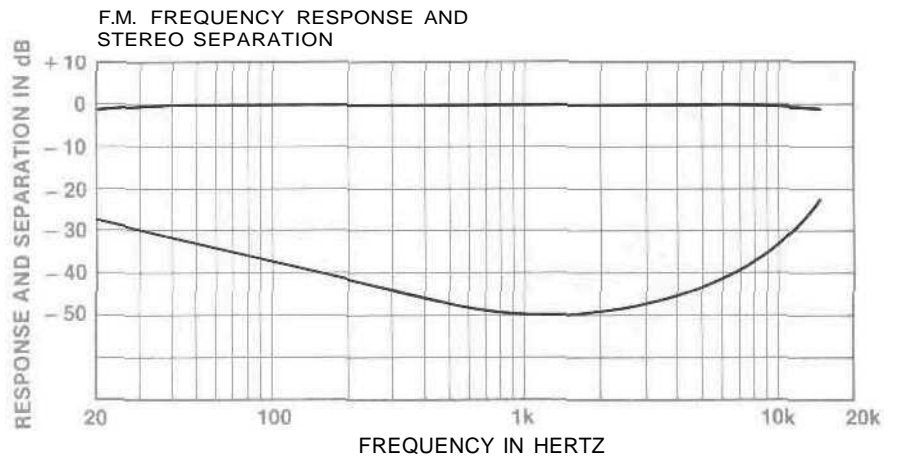
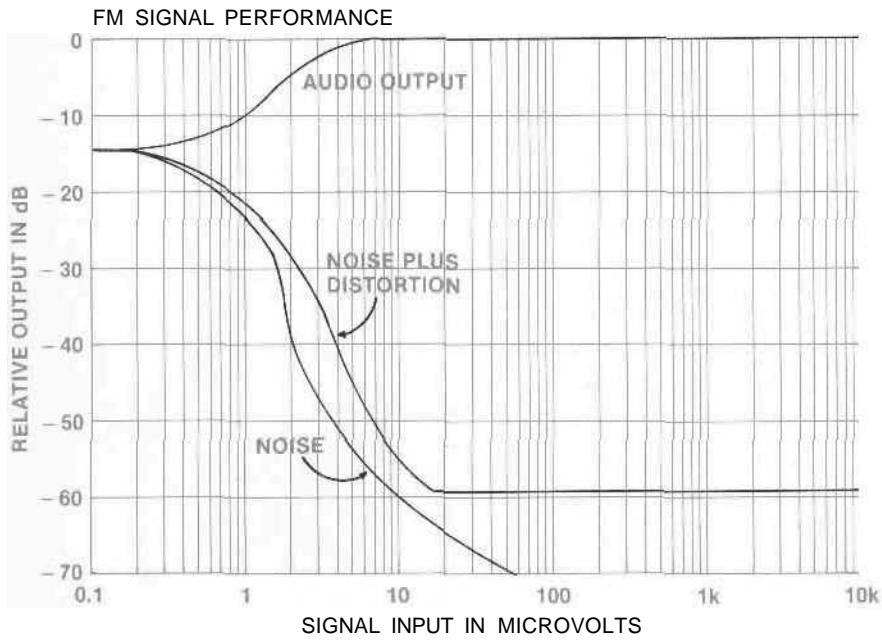

RF INPUT USING DUMMY ANTENNA IN MICROVOLTS

AM MINIMUM USABLE SENSITIVITY (IHF)

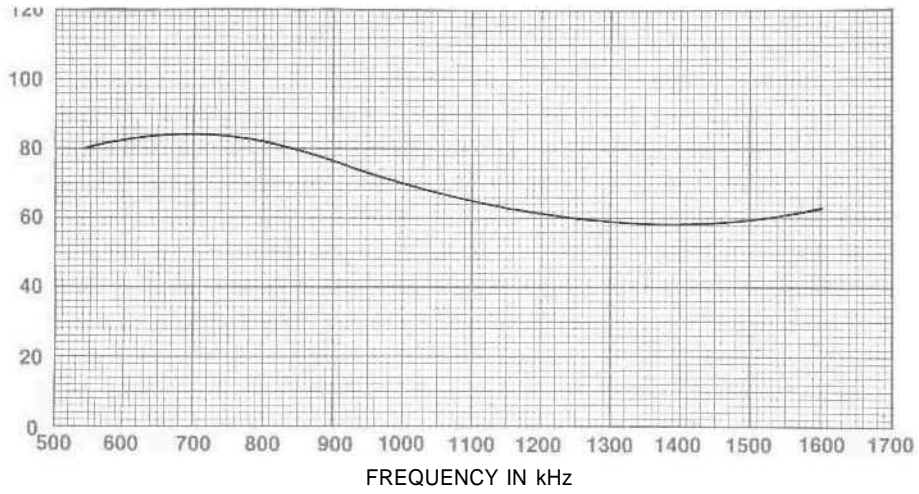

A.M. FREQUENCY RESPONSE  
80% Modulation

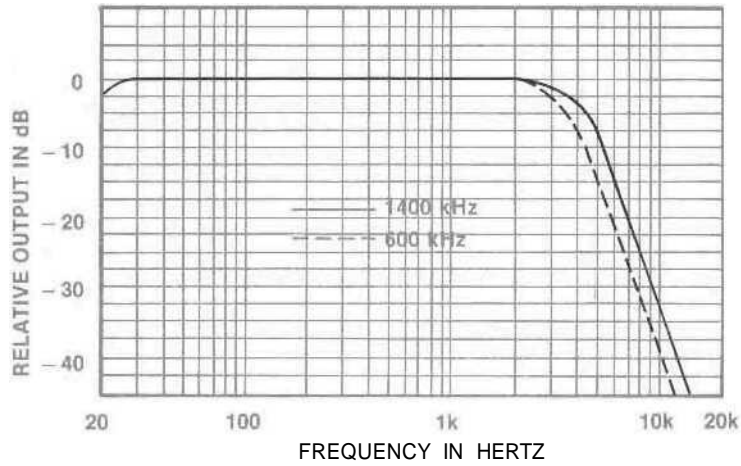

AM SELECTIVITY  
AT 1000 kHz

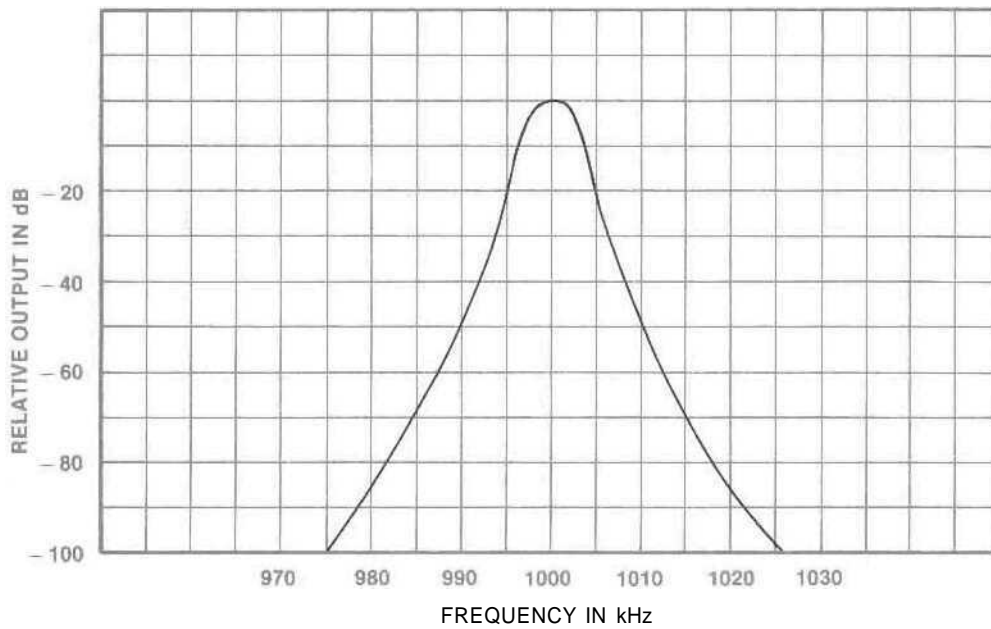



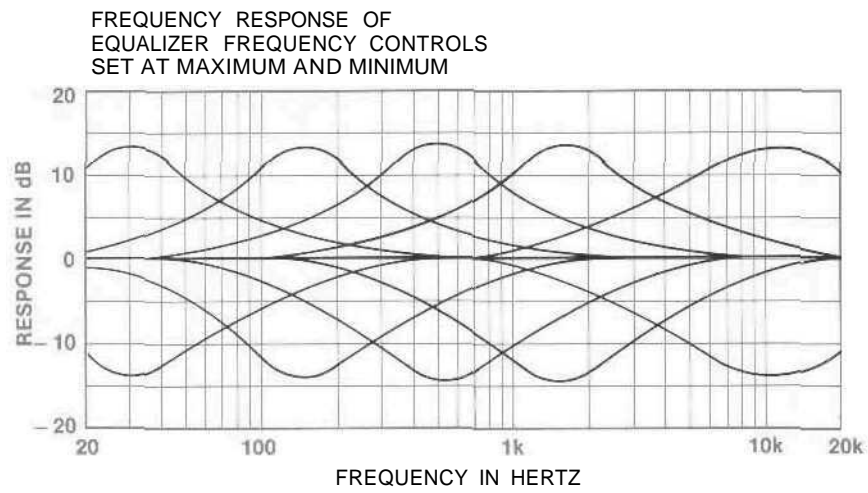
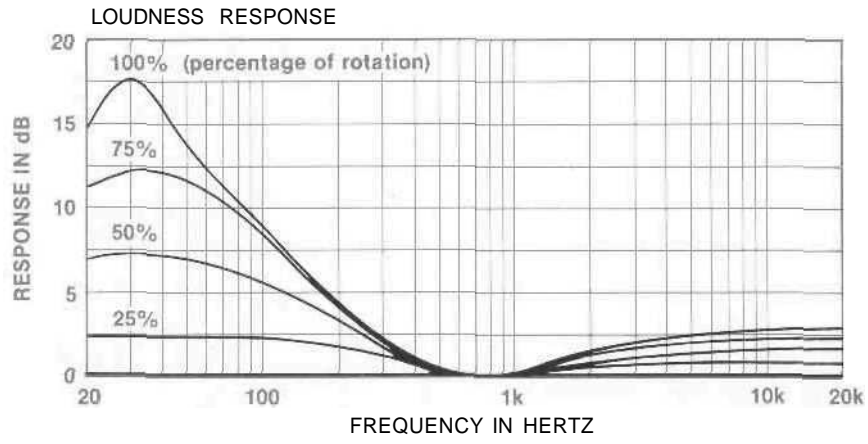

# Block Diagram

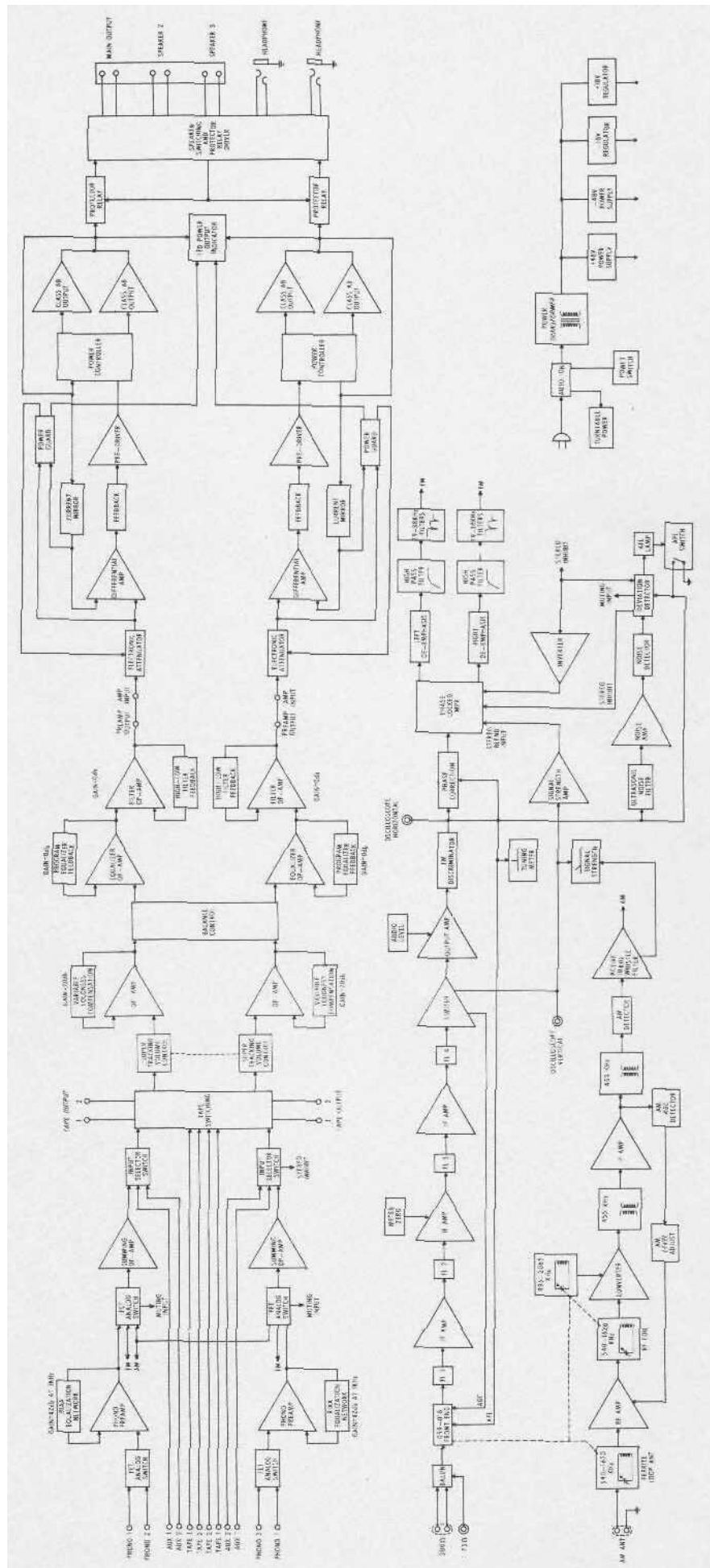

# McIntosh

MCINTOSH LABORATORY INC.  
2 CHAMBERS ST., BINGHAMTON, N.Y. 13903

**607-723-3512**

The continuous improvement of its products is the policy of  
McIntosh Laboratory Incorporated who reserve the right to  
improve design without notice.

Printed in U.S.A.

**039222**